

RADIO YourWay LX

AM/FM RADIO RECORDER



AM/FM Radio Recorder/Voice Recorder/MP3, WMA Player



This manual is protected by copyright laws and all rights are reserved. No portion of this manual may be reproduced in any form or translated into other languages without written permission from the manufacturer and publisher of this manual. The content of this manual is provided “as is” and the manufacturer is under NO obligation to notify users of revisions or modifications to the product or procedures. Every effort has been taken to ensure the accuracy of the information herein. However, the manufacturer is not responsible for any inaccuracies or omissions that may affect the units operation. We recommend you read the entire manual to get the most enjoyment out of your new Radio YourWay LX.

TABLE OF CONTENTS

I. COMPONENT and LCD DISPLAY

1. SET
2. Accessories
3. LCD Display

II. BATTERY CHARGE and USE

1. Charge battery using AC Adapter
2. Charging Status
3. Battery Level
4. Battery Life
5. Powering on

III. MEMORY CARD and RESET

1. Memory Card
2. Maximum Recording Time
3. Precautions
4. Inserting a memory Card
5. Reset Unit

IV. RADIO YOURWAY LX MODES

- 1. Music mode**
- 2. Voice mode**
- 3. AM mode**
- 4. FM mode**

V. RECORDING, PLAYBACK, and DELETING

- 1. AM and FM**
- 2. Record and Playback Voice**
- 3. Deleting Files**

VI. TIMER-RECORDING

- 1. Setting Current Time**
- 2. Setting Current Date**
- 3. Setting a Timer-Recording**
- 4. Reviewing a Timer-Recording**
- 5. Deleting a Timer-Recording**

VII. BASIC BUTTON OPERATIONS

VIII. MAIN MENU STRUCTURE

- 1. System**
- 2. Play**
- 3. Recording**
- 4. Display**
- 5. Sound**

IX. PLAY STYLE MENU

X. FURTHER OPERATION

1. Playback Speed
2. AM/FM Radio
3. Formatting
4. Complete Format

XI. COMPUTER CONNECTION

1. Win XP, 2000, ME, and Mac OSX+
2. Driver Installation for Win98SE
3. PC Connection Display
4. Safely Removing Hardware from a PC

XII. DISPLAY MESSAGES

General Specification

Warranty

I. COMPONENT and LCD DISPLAY

1. SET

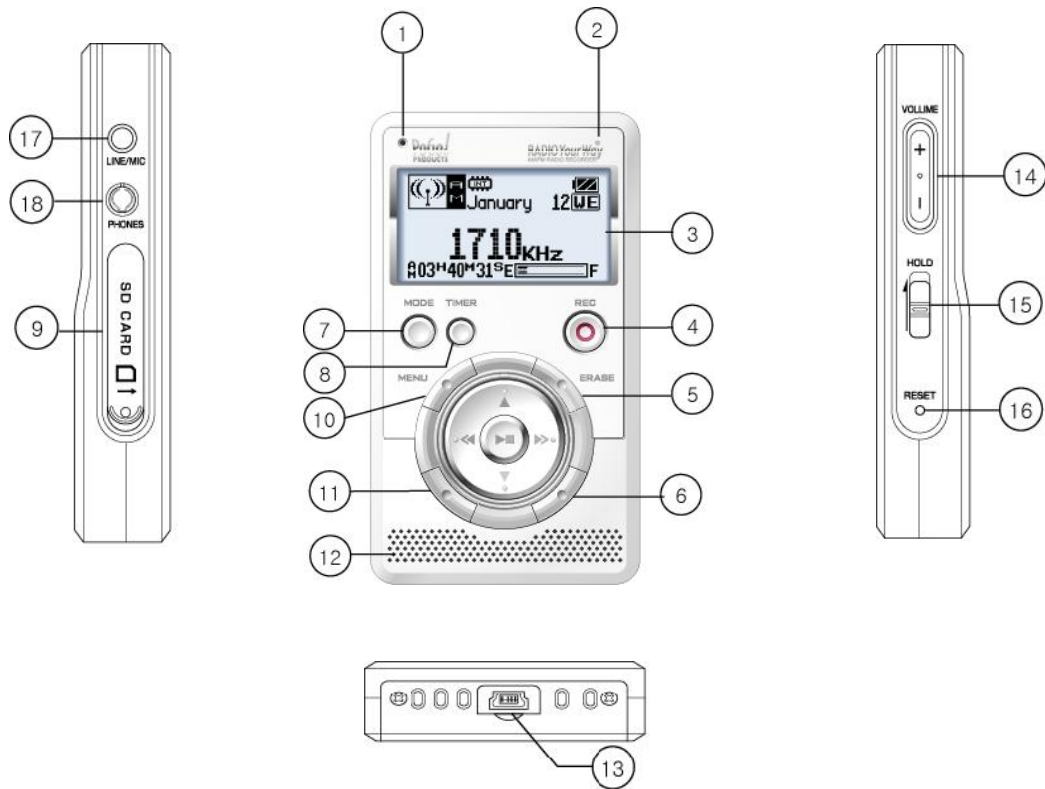

①	Internal Microphone	⑩	MENU
②	LED	⑪	SPEED
③	LCD	⑫	External Speaker
④	REC	⑬	USB/POWER Terminal
⑤	ERASE	⑭	Volume +/-
⑥	A↔B/Repeat	⑮	HOLD
⑦	MODE	⑯	RESET
⑧	TIMER	⑰	LINE IN
⑨	SD/MMC Card Slot	⑱	Earphone Jack

2. Accessory

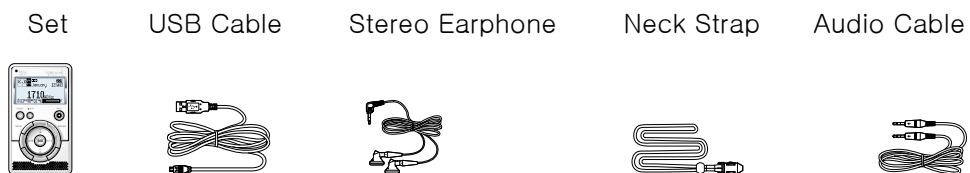

AC Adapter FM Antenna User Guide

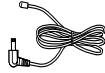

3. LCD Display

■ POWER ON



■ POWER OFF



■ AM Display

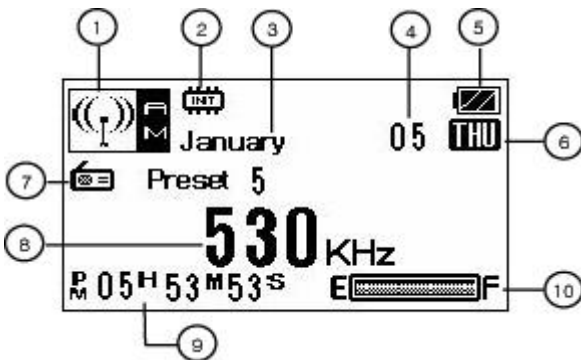

- ① : Radio band
- ② : Memory(Internal/External)
- ③ : Month(Calendar)
- ④ : Date(Calendar)
- ⑤ : Battery Level
- ⑥ : Day(Calendar)
- ⑦ : Preset Frequency NO
- ⑧ : Frequency
- ⑨ : Present Time
- ⑩ : Remaining memory status

■ FM Display

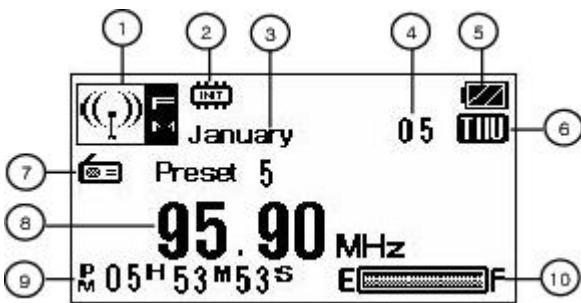

- ① : Radio band
- ② : Memory(Internal/External)
- ③ : Month(Calendar)
- ④ : Date(Calendar)
- ⑤ : Battery Level
- ⑥ : Day(Calendar)
- ⑦ : Preset Frequency NO
- ⑧ : Frequency
- ⑨ : Present Time
- ⑩ : Remaining memory status

■ MUSIC Initial Display

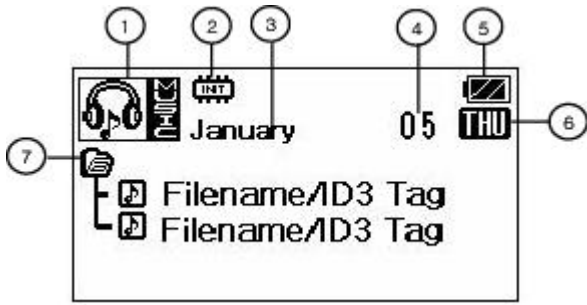

- ① : MUSIC Mode
- ② : Memory(Internal/External)
- ③ : Month(Calendar)
- ④ : Date(Calendar)
- ⑤ : Battery Level
- ⑥ : Day(Calendar)
- ⑦ : Navigation (Music list up)

■ MUSIC Playback Display

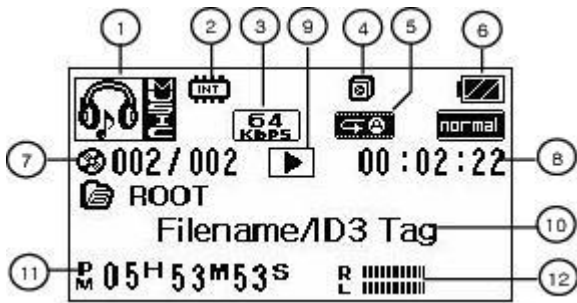

- ① : Music band
- ② : Memory(Internal/External)
- ③ : Recording bit rate
- ④ : Sound effect
- ⑤ : Repeat
- ⑥ : Battery level
- ⑦ : Playing music NO/Total music No
- ⑧ : Playing time
- ⑨ : Play Status
- ⑩ : Music File Information
- ⑪ : Present time
- ⑫ : L/R Sound Level

■ VOICE Initial Display

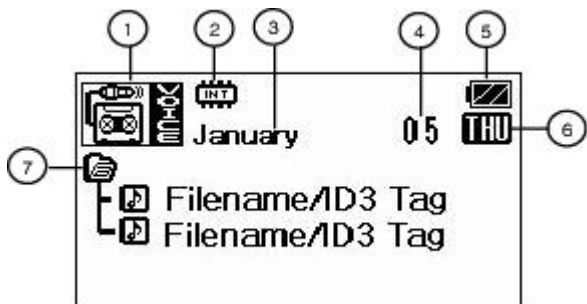

- ① : VOICE Mode
- ② : Memory(Internal/External)
- ③ : Month(Calendar)
- ④ : Date(Calendar)
- ⑤ : Battery Level
- ⑥ : Day(Calendar)
- ⑦ : Navigation

II. BATTERY CHARGE and USE

1. Charge battery using AC Adapter

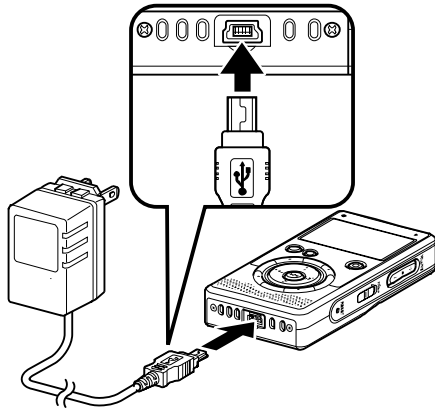

- Connect the adaptor jack as shown in the diagram; taking note of the correct side.
- The battery can be charged using the AC adaptor, or by making a USB connection with a PC or MAC.
- It takes approximately 4hrs to fully charge the battery using either method.
 - ☞ The 4hr charge time (for a full charge) is an estimate only. Actual time may vary depending on charging conditions.

2. Charging Status

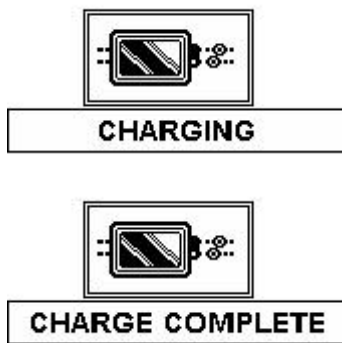

Charging

Charge Complete

3. Battery Level

	Full charge
	Some power consumed
	Power almost drained, should charge battery
	No power, charge battery

4. Playback and Recording Battery Life

LX battery lasts an average of 7 – 10 hours under normal use.

☞ Actual battery life may vary depending on use.

Before recording for a long period of time, please fully charge the battery.

A Li-polymer battery has its own battery life. If battery consumption has changed drastically, please replace the battery with a new one from www.pogoproducts.com

5. Powering On

After charging the battery, press and hold the **Play/Stop** button for 3 seconds to power on.

III. MEMORY CARD and RESET

1. Memory Card

- 1) Memory Card Type: SD/MMC Card
- 2) Compatible Capacity: 32MB / 64MB / 128MB / 256MB / 512MB / 1GB

☞ An external memory card is not provided. You can buy one from just about any electronics store in your area.

* Radio YourWay LX only supports STANDARD SD cards. High-Speed cards will NOT work.

2. Maximum Recording Time

- 128MB: 85hrs at 32Kbps
- 256MB: 17hrs at 32Kbps
- 512MB: 34hrs at 32Kbps
- 1GB: 68hrs at 32Kbps

3. Precaution

- 1) Do not take the memory card out while the unit is playing back or recording a file.
- 2) When using a new memory card, format the card inside the unit BEFORE using it.
- 3) If the memory card has been used in any device, (Digital Camera, MP3 Player, etc) you must format the card in Radio YourWay LX before use. Memory cards must be formatted in FAT.
- 4) We do not recommend using a memory card in multiple devices.
- 5) Only insert or remove card when unit is powered off.

4. Inserting a Memory Card



☞ When inserting a memory card in the unit, be careful and insert the card properly as shown in the diagram (taking note of the correct side up) or you may damage the card and/or Ext card slot. Press the A/B – Repeat button to switch from Internal to External memory, or vice-versa.



5. Reset

If the unit is not responding, please reset by pushing the Reset button (found on the right side of the unit) gently with a thin object for 1 second.

IV. RADIO YOURWAY LX MODES

* Display for Modes

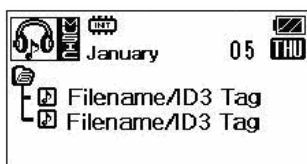

Music Mode

Mode

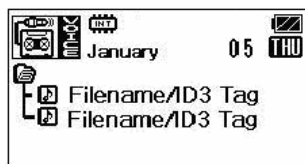

Voice Mode



AM Mode

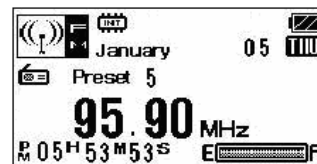

FM

① Music mode

All recordings done manually (see Chapter V for more details) will be found in the Music mode. By default, the Radio YourWay LX organizes the recordings by creating specific folders.

For example, an **AM** folder will be created under the Root when an AM recording is made. All further AM recordings will be stored in that folder.

Music mode will also store MP3's and WMA files that you download from a computer.

NOTE: Folders will not appear if the Play Style is set to File List. See the Play Style Menu chapter for more details.

② Voice mode

NOTE: For more on Timer-Recordings, please refer to Chapter VI – Timer-Recording.

All recordings made by the Timer-Recording feature will be found in Voice mode. When a Timer-Recording is made, a **Schedule** folder will appear underneath Root.

Folders will not appear if the Play Style is set to File List. See the Play Style Menu chapter for more details.

③ AM mode

You can listen to AM radio in AM mode.

④ FM mode

You can listen to FM radio in FM mode.

V. RECORDING, PLAYBACK, and DELETING

1. AM and FM

Switch to the desired mode by tapping the Mode button. Once you are in the desired mode (AM or FM), tune in to the station you would like to record by pressing the **Fast Forward button (>>)** or **Rewind button (<<)**. To scan for stations, press and hold the **Fast Forward button (>>)** or **Rewind button (<<)** for 3 seconds.

Once you have tuned into your desired station, press the **REC** button to begin recording. To pause the recording, simply tap the **REC** button. PAUSE will display on the screen. Tap the **REC** button again to resume recording. The recording light will be solid red while recording.

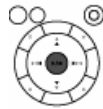

To stop the recording, tap the Play/Stop button.

To playback the recording, tap the Mode button until you are in Music mode. Select the AM or FM folder using the **Up** or **Down** button, then press the **Play/Stop** button to access it. Once you are in the folder, select your recording using the **Up** or **Down** button. Press the **Play/Stop** button to begin playback.

To stop or pause playback, tap the **Play/Stop** button during playback.

NOTE: To go back to the root of the LX, tap the **Play/Stop** button during playback to stop the playback. Tap the **Up** or **Down** button to go to the previous screen. Next, tap the **Rewind button (<<)** until you are at the root. Use this method to access files located in other folders.

NOTE: Folders will not appear if the Play Style is set to File List. See the “Play Style” section in the Main Menu chapter for more details.

2. Record and Playback Voice

Switch to Music or Voice mode by tapping the Mode button. Once you are in Music or Voice mode, tap the **REC** button to begin recording. To pause the recording, simply tap the **REC** button. PAUSE will display on the screen. Tap the **REC** button again to resume recording. The recording light will be solid red while recording.

To stop the recording, tap the **Play/Stop** button. You will automatically be taken into the MIC folder (where all voice recordings will be stored) in Music mode.

To playback the recording, select the file using the **Up** or **Down** button. Press the **Play/Stop** button to begin playback.

To stop or pause playback, tap the **Play/Stop** button during playback.

NOTE: Folders will not appear if the Play Style is set to File List. See the Play Style Menu chapter for more details.

3. Deleting Files

You can delete files/recordings in Music or Voice mode. To delete files/recordings, tap the **Mode** button until you are in the desired mode. Select the file/recording you wish to delete using the **Up** or **Down** button, then tap the **Erase** button.

A pop-up screen will appear displaying “Delete – Yes/NO?”

Select “Yes” using the **Fast Forward** button (>>) or **Rewind** button (<<), then press the **Play/Stop** button to confirm.

If you do not wish to delete the file/recording, select “NO” and press the **Play/Stop** button to confirm.

You cannot delete while listening to a playback. You must first stop the playback by tapping **Play/Stop** button. Next, tap the **Up** or **Down** button to go back to the previous screen.

NOTE: If your file/recording is stored in a folder, such as the SCHEDULE folder in Voice mode, you must enter that folder in order to access the file/recording. If you tap the **Erase** button while highlighting a folder and select “YES” to erase, you will be deleting all contents within that folder.

If you wish to delete all files/recordings within the Music or Voice mode, press and hold the **Erase** button in the desired mode until you see the “Delete All?” message. Select “Yes” using the **Fast Forward** button (>>) or **Rewind** button (<<), then press the **Play/Stop** button to confirm.

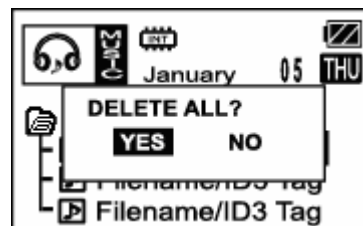
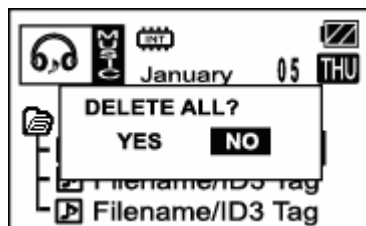

VI. TIMER RECORDING

The Timer-Recording feature allows Radio YourWay LX to record unattended.

1. Setting Current Time

In order for Timer Recordings to function properly, the current time and date MUST be set. Make sure you always have enough battery power. After 1 or 2 hours of the battery being fully discharged, the

year/day/hour settings will not be able to stay current.

Tap the **Menu** button to go into the Menu System. With Time Set highlighted, tap the **Play/Stop** button.

You will now see the Time Set screen, just like the example picture.

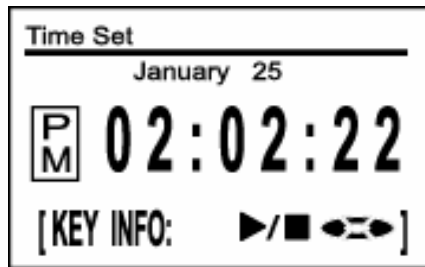

To change the Hour/Minutes, use the **Up** or **Down** button. To move between the Hour and Minute fields, use the **Fast Forward** button (>>) or **Rewind** button (<<). Push the **Play/Stop** button to confirm when you are finished.

2. Setting Current Date

Tap the **Menu** button to go into the Menu System. Highlight Calendar using the **Up** or **Down** button, then press the **Play/Stop** button to enter.

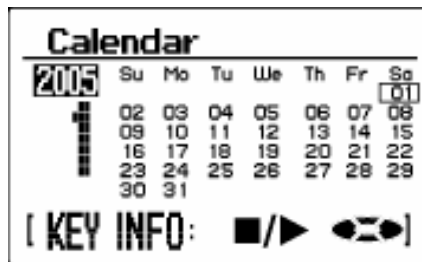

To change the Year, Month, or Day, use the **Fast Forward** button (>>) or **Rewind** button (<<). To move between the Year, Month, or Day fields, use the **Up** or **Down** button. Push the **Play/Stop** button to confirm when you are finished.

Once you have set the current date and time, press the **Menu** button to exit Menu System.

3. Setting a Timer-Recording

Tap the **Timer** button in Music, Voice, AM, or FM mode. A pop-up will appear displaying "Set" and "Review."

Select "Set" using the **Fast Forward** button (>>) or **Rewind** button (<<), then press the **Play/Stop** button.

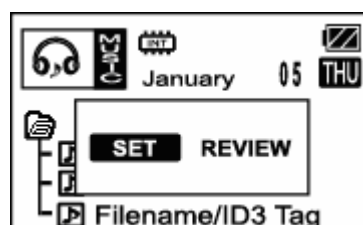

NOTE: You cannot set a timer recording when the unit is playing back a file, recording, or in the Menu mode.

Once you are in the Schedule Set screen, use the **Up** or **Down** button to move through the fields. Use the **Fast Forward button (>>)** or **Rewind button (<<)** to change the field setting.

A. The first field is **SCHEDULE SET**. Select a schedule using the **Fast Forward button (>>)** or **Rewind button (<<)**. There are 20 scheduling sets available.

B. The next field is **TYPE**. Use the **Fast Forward button (>>)** or **Rewind button (<<)** to select **RECORD**, **PLAY**, or **DELETE**.

RECORD – Record on a set time and date. (Timer Recording)

PLAY – Play music or radio on a set time and date. (Alarm Function)

DELETE – Select this to delete the schedule made.

C. The next field is **MEMORY**. Select the memory you wish to record on or play from (**INTERNAL** or **SD CARD**) using the **Fast Forward button (>>)** or **Rewind button (<<)**. Note that you may only select **SD CARD** if you have an external memory card inserted.

D. The next field is **DATE SET**. You may set the schedule to work on a weekly basis or on a specific date. Use the **Fast Forward button (>>)** or **Rewind button (<<)** to select **WEEK** or **DATE**.

E. The next field is **WEEK** if the previous field is set to **WEEK**. You may select **EVERY DAY**, **MON – SAT**, **MON – FRI**, or individual days of the week. Use the **Fast Forward button (>>)** or **Rewind button (<<)** to select the days.

Note that this field will be **DATE** if the previous field is set to **DATE**. With the Month highlighted, use the **Fast Forward button (>>)** or **Rewind button (<<)** to select the desired month to record. Next, press the **Down** button to switch to the day. Use the **Fast Forward button (>>)** or **Rewind button (<<)** to select the desired day to record.

To go back to the month, press the **Up** button. To move to the next field, press the **Down** button.

F. The next field is **SOURCE**. You may select from which source you would like to record from (**AM**, **FM**, **MIC**, or **LINE-IN**) using the **Fast Forward button (>>)** or **Rewind button (<<)**.

Note that **MUSIC**, **AM**, or **FM** will be the only choices if the **TYPE** field is set to **PLAY**.

If you set the source to MUSIC, you must select a file to play. Press the **Down** button to highlight the folder underneath **SOURCE**. Select the desired folder that contains your file using the **Fast Forward button (>>)** or **Rewind button (<<)**. If you do not have any folders stored in Radio YourWay LX, then Root will be the default folder selected.

Once you have selected the folder, press the **Down** button to highlight the file. Select your desired file to play using the **Fast Forward button (>>)** or **Rewind button (<<)**.

To go back to the folder or Source selection, press the **Up** button. To move to the next field, press the **Down** button.

G. The next field is **PRESET**. You may select a preset radio station using the **Fast Forward button (>>)** or **Rewind button (<<)**.

This field is unavailable if the **SOURCE** field is set to MIC or LINE-IN.

This field is also unavailable if the **TYPE** field is set to PLAY, with **SOURCE** set to MUSIC.

H. The next field is **FREQ**. You may select a radio station using the **Fast Forward button (>>)** or **Rewind button (<<)**.

This field is unavailable if the **SOURCE** field is set to MIC or LINE-IN.

This field is also unavailable if the **TYPE** field is set to PLAY, with **SOURCE** set to MUSIC.

I. The next field is **BITRATE**. Bit-rate determines the quality of the recording. The higher the bit-rate, the higher the quality will be. Please note that higher bit-rates will reduce the overall amount of recording time.

Select the desired bit-rate using the **Fast Forward button (>>)** or **Rewind button (<<)**. Recommended bit-rates when recording voice or talk shows are 32KBPS and 64KBPS. Recommended bit-rates when recording music are 128KBPS and above.

This field is unavailable if the **TYPE** field is set to PLAY.

J. The next field is **START**. Set the hour you wish to start the automatic recorder using the **Fast Forward button (>>)** or **Rewind button (<<)**. You can change AM to PM, or vice-versa, by continuously tapping the **Fast Forward button (>>)** or **Rewind button (<<)**.

Once you have set the starting hour, tap the **Down** button to select the starting MINUTES. Use the **Fast Forward button (>>)** or **Rewind button (<<)** to set the starting minutes.

You can go back to the starting hour by tapping the **Up** button.

K. The next field is **END**. Set the hour you wish to end the automatic recorder using the **Fast Forward button (>>)** or **Rewind button (<<)**. You can change AM to PM, or vice-versa, by continuously tapping the **Fast Forward button (>>)** or **Rewind button (<<)**.

Once you have set the ending hour, tap the **Down** button to select the ending MINUTES. Use the **Fast Forward button (>>)** or **Rewind button (<<)** to set the ending minutes.

You can go back to the ending hour by tapping the **Up** button.

Once you've set the ending time, tap the **Play/Stop** button. A pop-up showing "DATA SAVE? YES / NO" will appear.

Select "YES" using the **Fast Forward button (>>)** or **Rewind button (<<)**, then tap the **Play/Stop** button to confirm.

The recording light will blink during a Timer-Recording session.

If you try to save the schedule without entering an ending time, you'll get an error message "NOT USED END TIME."

If you try to create another schedule with overlapping times and/or dates, you'll get an error message "OVERLAP SCHEDULE."

To exit the Schedule Screen without saving, tap the **Erase** button to bring up the Exit screen. Select "YES" using the **Fast Forward button (>>)** or **Rewind button (<<)**, then tap the **Play/Stop** button to exit

4. Reviewing a Timer-Recording

To review Timer-Recordings you've made, tap the **Timer** button in Music, Voice, AM, or FM mode. A pop-up will appear displaying "Set" and "Review."

Select "Review" using the **Fast Forward button (>>)** or **Rewind button (<<)**, then press the **Play/Stop** button.

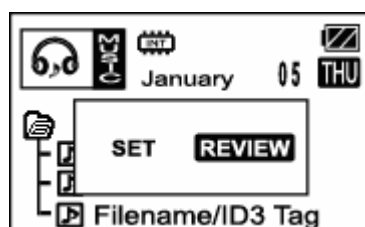

Once you are in the Schedule Review screen, use the **Up** or **Down** button to view the fields.

The first field, **Schedule REVIEW**, will display the Schedule number out of how many schedules you've made. For example, Schedule REVIEW 3/6 indicates that you are reviewing Schedule #3, out of six schedules made.

Tap the **Erase** button to exit Schedule Review screen.

5. Deleting a Timer-Recording

Tap the **Timer** button in Music, Voice, AM, or FM mode. A pop-up will appear displaying “Set” and “Review.”

Select “Set” using the **Fast Forward** button (>>) or **Rewind** button (<<), then press the **Play/Stop** button.

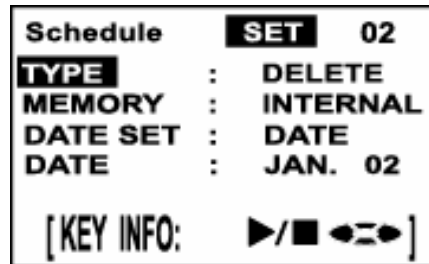

Use the **Up** or **Down** button to highlight the **TYPE** field. Use the **Fast Forward** button (>>) or **Rewind** button (<<) to select **DELETE**.

Tap the **Play/Stop** button. A pop-up showing “DATA SAVE? YES / NO” will appear.

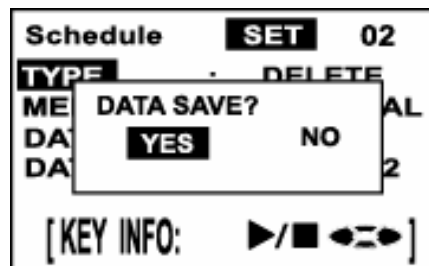





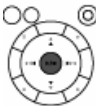

Select “YES” using the **Fast Forward** button (>>) or **Rewind** button (<<), then tap the **Play/Stop** button to confirm.

The schedule is now deleted.



VII. BASIC BUTTON OPERATIONS

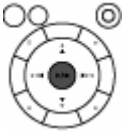

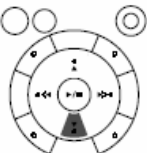

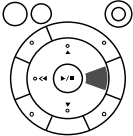
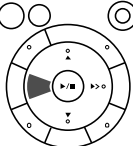
Please study the chart below “—” means holding the specified key for 1second and “——” means holding the specified key for 2–3seconds. Please make a note of this.

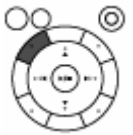
Key	Function
Power On/Off	 Power On: Hold  button for 2–3 seconds. Power Off: Hold  button for 2–3 seconds.
Hold	 Hold Off.



		Hold On. Will disable button use.
Playback and Stop		<p>Power ON/OFF — : Power On/Off.</p> <p>MUSIC/VOICE Mode —: Select/Play back file and stop/Pause a file.</p> <p>During a recording and paused recording. —: Stop recording.</p> <p>Selecting a folder in file display mode. —: Select Directory/File.</p> <p>Play style/Main Menu —: Confirm the menu selection.</p> <p>Timer-Recorder (Timer Reservation) —: Save the Timer-Recording.</p> <p>During a timer recording. —: Stop the timer recording.</p>
FILE UP		<p>MUSIC/VOICE Mode</p> <p>① In selecting file —: Scroll up through available files. —: Scroll up through available files faster.</p> <p>② During Play back —: Skip to the beginning of the current file. —: Scroll through available files.</p> <p>③ Player Stopped —: Select a different file/directory or option.</p> <p>AM/FM Mode —: Search for a preset station</p> <p>Play style/Main Menu/ Timer-Recording —: Move up to another directory/option/item</p>
Key		Function
FILE DOWN		<p>MUSIC/VOICE Mode</p> <p>① Selecting a file. —: Scroll through available files. —: Scroll through available files faster.</p> <p>② During Play back —: Skip to the beginning of the next file. —: Scroll through available files.</p> <p>③ Player Stopped —: Return to previous directory.</p> <p>AM/FM Mode</p>

		<p>—: Search for a preset station.</p> <p>Play style/Main Menu/ Timer-Recording</p> <p>—: Move up to another directory/option/item.</p>
FF		<p>MUSIC/VOICE Mode</p> <p>① During Play back</p> <p>—: 10 Seconds a second fast forward.</p> <p>—: 1 minute a second fast forward.</p> <p>② Player Stopped</p> <p>—: 10 Seconds a second fast forward.</p> <p>—: 1 minute a second fast forward.</p> <p>③ Selecting Folder in file display mode</p> <p>—: Return to previous directory.</p> <p>AM/FM Mode</p> <p>—: Tuning to Next (higher frequency) Station.</p> <p>—: Search through stations.</p> <p>Play style/Main Menu/ Timer-Recording</p> <p>—: Move up to another directory/option/item.</p>
REW		<p>MUSIC/VOICE Mode</p> <p>① During Play back</p> <p>—: 10 Seconds a second rewind.</p> <p>—: 1 minute a second rewind.</p> <p>② Selecting a Folder in file display mode</p> <p>—: Return to previous directory.</p> <p>AM/FM Mode</p> <p>—: Tuning to previous (lower frequency) Station.</p> <p>—: Search through stations.</p> <p>Play style/Main Menu/ Timer-Recorder (Reservation)</p> <p>—: Move up to another directory/option/item.</p>

Key		Function
MENU		<p>—: Display Main Menu</p> <p>Setup System/Play/Record/Display/Sound options.</p> <p>NOTE: Pressing menu in the Display Main Menu will exit the Display Main Menu.</p>
SPEED		<p>MUSIC/VOICE Mode</p> <p>① During Playback</p> <p>—: Change Playback speed.</p> <p>Each Press will change playback speed as follows: X1.3spd, X1.5spd, X0.5spd, X0.7spd</p> <p>—: Change EQ</p>

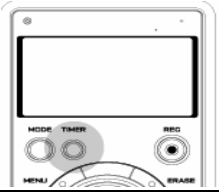
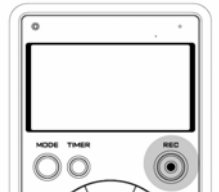
		<p>② Selecting a file</p> <p>—: Bookmark</p> <p> Only applicable for MP3 files.</p>
ERASE		<p>MUSIC/VOICE Mode</p> <p>① Selecting a file</p> <p>—: Erase the selected file or folder.</p> <p>—: Erase all files and folders</p> <p>Main Menu</p> <p>—: Escape from the main menu.</p> <p>Timer Recording</p> <p>—: Exit Timer-Recording.</p>
A↔B/Repeat		<p>MUSIC/VOICE Mode</p> <p>① Player Stopped (Except in Display Main Menu)</p> <p>—: Select Internal or External Memory.</p> <p>② During Playback</p> <p>—: Select “A-B Repeat” or “One touch Repeat”</p> <p>—: Change File Repeat Option.</p>
Mode		<p>—: MUSIC,VOICE,AM,FM Mode Selection.</p> <p>MUSIC/VOICE Mode</p> <p>—: Select the play style.</p>
Volume		<p>Volume Up and Down</p> <p>—: Increase/decrease the Volume.</p> <p>—: Increase/decrease the Volume faster.</p>



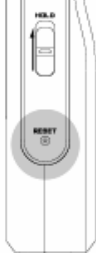



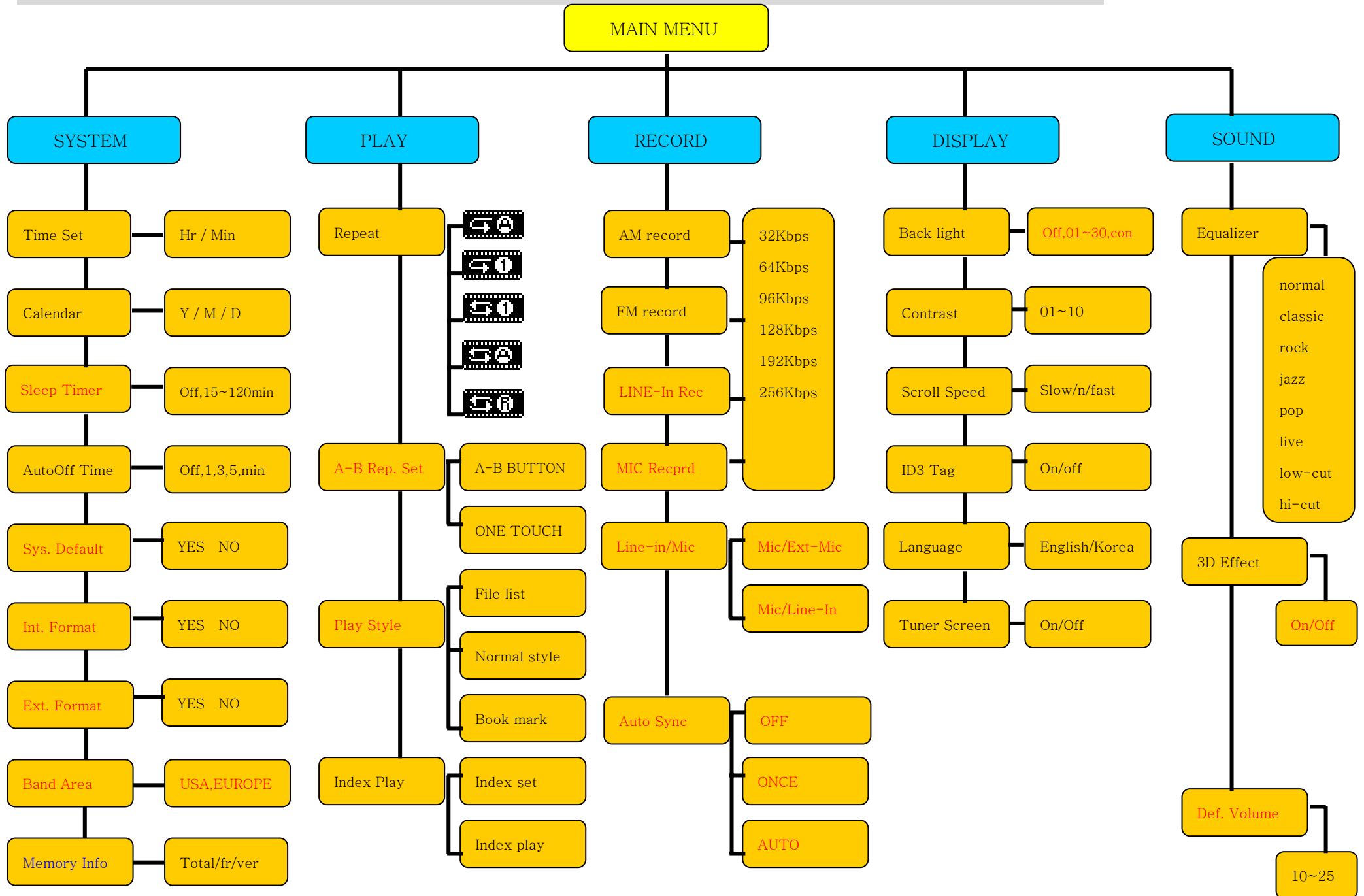

Key		Function
TIMER		—: Display Timer Recording SET/REVIEW.
REC		<p>MUSIC/VOICE Mode</p> <p>① In file selection</p> <p>—:Record through internal or external Microphone.</p> <p>AM/FM Mode</p> <p>—: Record AM/FM Radio.</p> <p>② Recording</p>

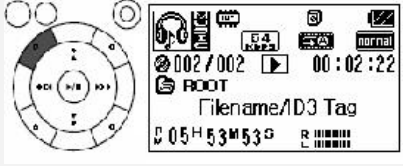

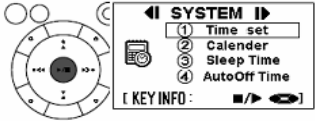



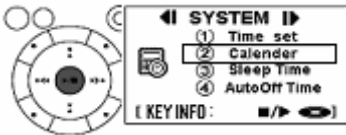
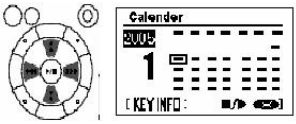

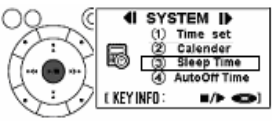
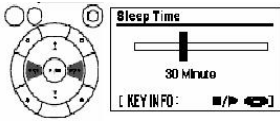
		<p>—: Pause recording.</p> <p>--: Setting Quick Timer Recording (0, 15min, 30min, 45min, OFF)</p> <p>③ Paused</p> <p>—: Restart recording.</p> <p>④ Timer-Recording</p> <p>—: Pause Timer-Recording.</p> <p>⑤ During a paused Timer-Recording</p> <p>—: Restart Timer-Recording.</p>
LED LAMP		<p>LED LAMP</p> <p>During a recording the LED will light up red.</p>
Internal Microphone		<p>Highly sensitive internal microphone used for recording.</p>
RESET		<p>– If the unit does not respond to any button presses, insert a thin object into the reset hole and gently push. After the reset, the unit will operate normally and no settings are lost.</p> <p>– Do not use a sharp object to reset the unit.</p>

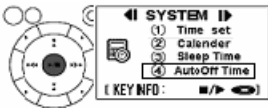
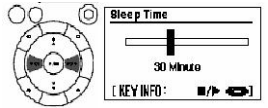
VIII. MAIN MENU STRUCTURE

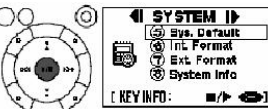
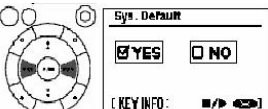

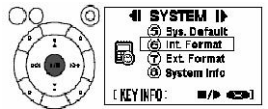
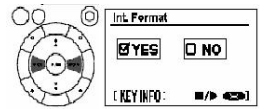
1. SYSTEM

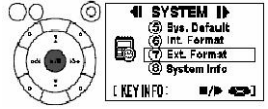
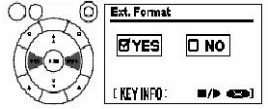

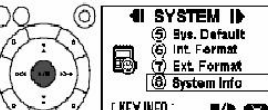

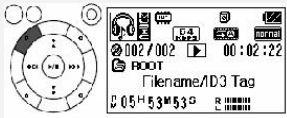
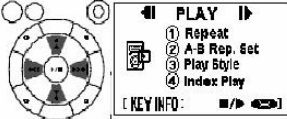

Key		Function	Setting
MENU	Display and Key operation		
SYSTEM		Used to Set: <ul style="list-style-type: none"> - Time set - Calendar - Sleep Timer - Auto Off Time - Sys Default - Int Format - Ext Format - Band Area - Memory Info. 	① Press "MENU"
			② Move to desired setting using ▲▼
TIME SET		Used to set the current time.	③ Select "Time Set" and press ►/■
			④ Setting Hour/Minute <ul style="list-style-type: none"> - Change time: ▲▼ - Moving between Hr and Min: <◀▶>
	 		⑤ Press ►/■ to set or exit by pressing "ERASE".
CALENDAR		Used to Set: <ul style="list-style-type: none"> - Present year - Present month - Present date ☞ Up to 2099 	③ Select "Calendar" and press ►/■
			④ Setting <ul style="list-style-type: none"> - Use ▲▼ to move between year, month and date. - Use ◀▶ to Change year, month and date
		Complete Setting	⑤ Press ►/■ to complete setting and exit.
SLEEP TIMER		Set unit to turn off after a designated time (15, 30, 45, 60, 75, 90, 105, 120 min)	③ Select "Sleep Timer" and press ►/■
			④ Use ◀▶ to select desired time.

		Complete Setting	⑤Press ▶/■ to complete setting and exit.
AUTO OFF Time		Unit will turn off when there are no button presses for the specified amount of time. (1, 3, 5 Min). Auto off doesn't work when playing back a file, recording, or when receiving a radio station	③Select "Auto Off Time" and press ▶/■
			④Use ◀▶ to select desired time.
		Complete Setting	⑤Press ▶/■ to complete setting and exit.
SYS Default		Use System Default to restore Menu settings back to its factory settings.	③Select "SYS Default" and press ▶/■
			④Use ◀▶ to select "YES" or "NO"
		Complete Setting	⑤Press ▶/■ to complete setting and exit.
INT FORMAT		Use Int Format to format the internal memory and erase all files.	③Select "Int format" and press ▶/■
			④Use ◀▶ to select "YES" or "NO"
		Complete Setting	⑤Press ▶/■ to complete setting and exit.
EXT Format		Use Ext Format to format an external memory card and erase all its files. You must format a memory card (using this method) BEFORE using it in the unit.	③ Select "Ext format" and press ▶/■
			④Use ◀▶ to select "YES" or "NO"
		Complete Setting	⑤Press ▶/■ to complete setting and exit.
MEMORY INFO		Used to see available memory.	③Select "Memory info" and press ▶/■

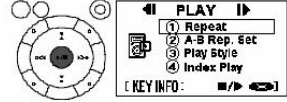
	Complete Setting	⑤ Press ►/■ to exit
---	------------------	---------------------

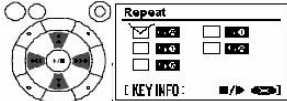





2. PLAY

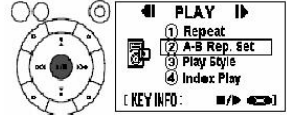
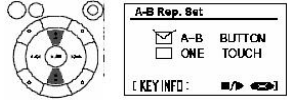

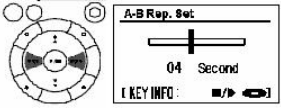
Key		Function	Setting
MENU	Display and Key operation		
PLAY		Used to Set <ul style="list-style-type: none"> - Repeat - A↔B/Repeat - Play style - Index Play 	① Press “MENU” and use ◀▶ to select the “PLAY” menu. ② Move to desired setting using ▲▼
			

REPEAT		 : Play all files in order and stop.	③ Select “REPEAT” and press ►/■ ④ Use ▲▼ and ◀▶ to select desired REPEAT Option.
		 : Play only 1 file and stop.  : Play 1 file repeatedly.  : Play files repeatedly in order. (5,4,3,2,1 etc)  : Randomly play all files.	

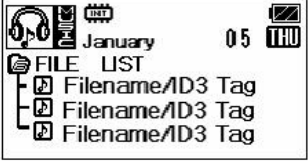
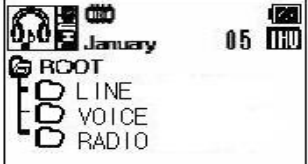
	Complete Setting	⑤ Press ►/■ to complete setting and exit.
---	------------------	---

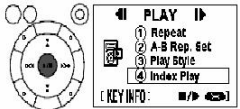
A↔B/Rep		A↔B Button: Repeatedly play a designated section of a file you select by pressing the (A-B) button at a beginning point and then again at an ending point ONE TOUCH: Press (A-B) button during the playback of a file. The unit will play the section repeatedly per the value selected (02, 04, 08, 16 sec)	③ Select “A↔B/Rep Set” and press ►/■ ④ Use ▲▼ to select desired option.
			

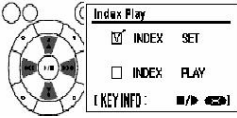
			⑤ If using ONE TOUCH option, select desired time (02, 04, 08 and 16 sec) by using ◀▶
		Complete Setting	⑥ Press ▶/■ to complete setting and exit
PLAY STYLE		Use to set playback settings - File List - Normal Style - Book-Mark List	③ Select “Play Style” and press ▶/■
			④ Use ▲▼ to select desired option and press ▶/■
		“FILE LIST” will show all files regardless of directory.	
		“NORMAL STYLE” (Directory View) view folders and/or files.	In this mode, select the desired folder by pressing ▶. Go back to previous folder by pressing ◀
		“BOOK MARK” will only show bookmark files, max 10. ★ Filename/ID3 Tag : In any play style mode, select a desired file to BOOKMARK & the file will now be marked by a star icon (shown above). If you press “SPEED” when a file has a star icon, it will release the bookmark and change the star icon back to a music icon. To see and listen to your bookmark files, select BOOK-MARK LIST from the PLAY STYLE menu.	Use the “SPEED” button to bookmark, or release a bookmark.
INDEX PLAY		Used to select a starting point that a file will begin playback from.	③ While listening to a file, select “INDEX PLAY” and press ▶/■



			<p>④ Press ◀▶ to set index and press ▶/■</p>
		<p>An index file plays from the selected point of the file.</p> <p>Only one point per file is applicable and if another file is indexed, the previous index is released.</p> <p>Index file can be played by pressing ▲▼ to select “Index Play” and pressing ▶/■</p>	<p>You can play index file by selecting “Index Play” and pressing ▶/■</p>



3. RECORDING

🔔 Precaution before recording

Please make sure of the following before recording:

- Select the internal or external memory.
- Check the amount of available memory.
- Select a bit rate. We recommend using the default bit-rates.
- Check the battery life.

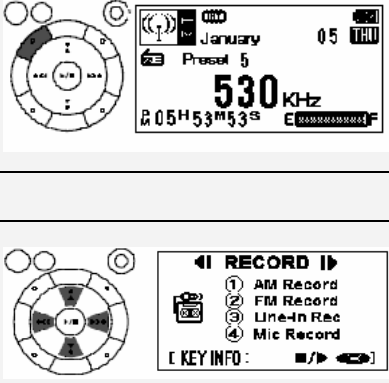
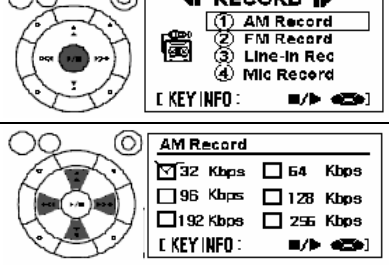
Key		Function	Setting
MENU	Display and Key operation		
Memory Type		 : Internal Memory  : External memory	Select Int memory or Ext memory by pressing the A-B/REPEAT button in AM, FM, MUSIC or VOICE mode.
		If you press “A-B/REPEAT” without a memory card in the external memory slot, the error “NOT INSERTED CARD” will appear.	

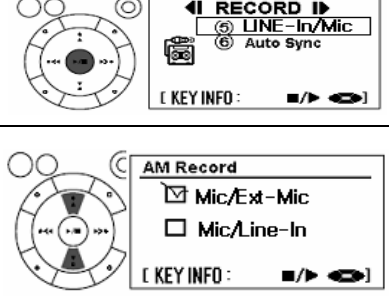
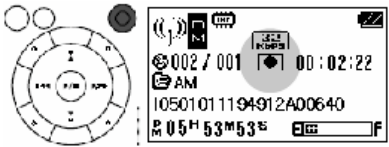
		<p>The memory remain icon is only displayed in AM/FM Mode.</p>	<p>Press “MODE” to select AM or FM in order to view how much memory remains.</p>
<p>RECORD</p>		<p>Same procedure is used to set:</p> <ul style="list-style-type: none"> - AM Record - FM Record - Line In Rec - Mic Record - Line-In/Mic - Auto Sync 	<p>①Press “MENU” and use ◀▶ to select the “RECORD” menu.</p> <p>②Select “AM, FM, Line-in or Mic Record” using ▲▼</p>
<p>SELECTING BIT RATE</p>		<p>The higher the bit rate the better quality the recording will be. However, the recording will use more memory space. Before recording, Please make sure you have enough memory available.</p>	<p>③Press ▶/■</p> <p>④Select desired “bit rate” using ▲▼◀▶</p>
		<p>Complete Setting</p>	<p>⑤Press ▶/■ to complete setting and exit.</p>
<p>Setting LINE-In/Mic</p>		<p>☞ When connecting the unit to an external device (lapel mic etc), the unit must be off.</p> <p>NOTE: MIC/Line-In option is used for LINE-IN/MIC-IN recording.</p>	<p>①Select “line-In/Mic” and press ▶/■</p> <p>②Use▲▼ to select desired option and press ▶/■</p>
<p>Recording AM/FM Radio</p>		<ul style="list-style-type: none"> - Recording format: MP3 - During a recording (“REC”) <ul style="list-style-type: none"> - RED LED is ON - MP3 File automatically created. 	<p>② Press “ REC” button to record.</p>

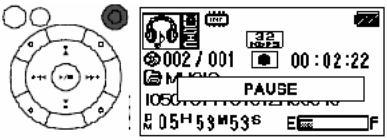
		<ul style="list-style-type: none"> - Record up to 999 files. - A file recorded from AM Radio, will be saved in the AM Folder. A file recorded from FM radio, will be saved in the FM folder. <p>☞ To view folders, make sure you set “PLAY STYLE” to NORMAL under the PLAY MENU</p>	<ul style="list-style-type: none"> ③ Press” REC” button to Pause. ④ Press “▶/■” to Stop recording.
--	---	---	--

Recording by External Microphone/Line-in

When trying to record using the External Mic/Line-in, make sure an external microphone and/or Line in cable is securely connected to the LINE/MIC jack (External Input Terminal) and make sure you set “**Mic/Ext-Mic to MIC/Line-In**” under the **RECORD MENU**.

☞ If an external microphone (lapel Mic etc) is connected, the internal microphone will not work.

Recording thru Ext Device



Connect one end of the Line-in cable to the headphone/line-out jack of your external device and the other end to the LINE/MIC jack of the set.

☞ When recording from an external device, adjust the volume of the source to avoid distorting the recording.

AUTO SYNC

AUTO SYNC REC: This separates a line-in recording into files by detecting the end of a file and creating a new file automatically while continuing or stopping the recording. You have 3 options:

① AUTO SYNC “OFF”

The file from the external device is recorded as one file only Simply press **RECORD** to start the recording and **PLAY** to stop it.



② AUTO SYNC “ONCE”

Only **ONE** file from the external device will be recorded Simply press **RECORD** and once the unit detects the end of the file, it will stop recording.

③ AUTO SYNC “AUTO”



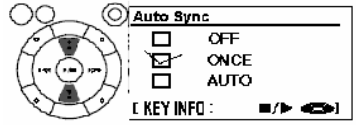

This separates the recording into individual files (one by one) by detecting the end of a file and creating new files until all the files from the external device are recorded. Simply press **RECORD** and once the unit detects that all files have been recorded, it will stop

recording.

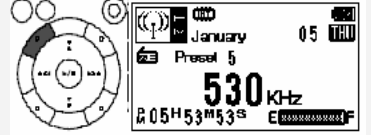
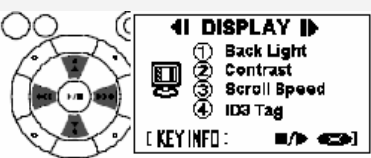
		<p>④ Select “Auto Sync” and press ►/■</p>
		<p>⑤ Select desired option using ▲▼</p>
	<p>Complete Setting</p>	<p>Press ►/■ to complete setting and exit.</p>

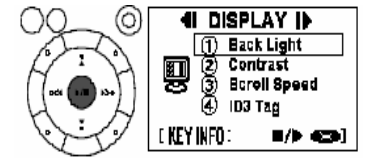
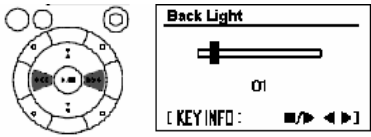

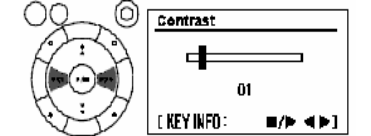
4. DISPLAY



Key		Function	Setting
MENU	Display and Key operation		
<p>DISPLAY</p>	 	<p>Use to set</p> <ul style="list-style-type: none"> - Back Light - Contrast - Scroll Speed - ID3 TAG - Language - Tuner Screen 	<p>① Press “MENU”</p> <p>② Use ◀▶ to select the “DISPLAY” menu.</p>

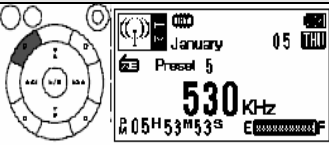

<p>BACK LIGHT</p>	 	<p>Select Backlight on time</p> <ul style="list-style-type: none"> - OFF : Always off - 01, 03, 05, 10, 20, 30 : Back Light on per selected time - Continue: Back Light always on. 	<p>③ Select “BACK LIGHT” using ▲▼ and press ►/■</p> <p>④ Set desired backlight time by using ◀▶</p>
		<p>Complete Setting</p>	<p>Press ►/■ to complete setting and exit.</p>
<p>Contrast</p>	 	<p>Adjust LCD Contrast</p> <p>Contrast Brightness Level 01, 02, 03, 04, 05, 06, 07, 08, 09, 10</p>	<p>③ Select CONTRAST using ▲▼ and press ►/■</p> <p>④ Set Contrast using ◀▶</p>
		<p>Complete Setting</p>	<p>Press ►/■ to complete setting and exit.</p>

Scroll Speed		Select how fast file info scrolls on the LCD screen.	③ Select “SCROLL SPEED” using ▲▼ and press ►/■
		Scroll Speed Option: – Slow, Normal, Fast	④ Select desired option using ◀▶
		Complete Setting	Press ►/■ to complete setting and exit
ID3 TAG		Display file information. ON: Title/Artist display. Off: No Title/Artist display.	③ Select “ID3 TAG” using ▲▼ and press ►/■
			④ Select desired option using ◀▶
		Complete Setting	Press ►/■ to complete setting and exit
Language		Display information on the LCD screen in the selected language.	③ Select “LANGUAGE” using ▲▼ and press ►/■
			④ Select desired option using ▲▼◀▶
		Complete Setting	Press ►/■ to complete setting and exit.
Tuner Screen		– Will turn off the Tuner Screen when receiving or recording AM/FM Radio.	③ Select “TUNER SCREEN” using ▲▼ and press ►/■
		– Turn OFF the Tuner Screen for better reception and recording quality. – Display will disappear after 5 seconds when Tuner Screen is set to OFF.	④ Select desired option using ◀▶
		Complete Setting	Press ►/■ to complete setting and exit

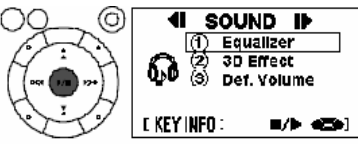
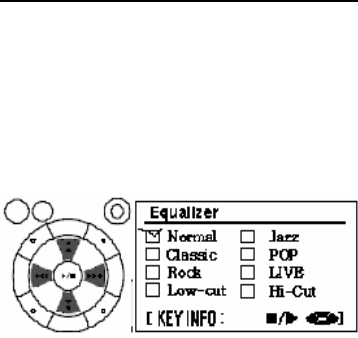
5. SOUND

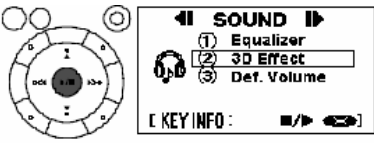
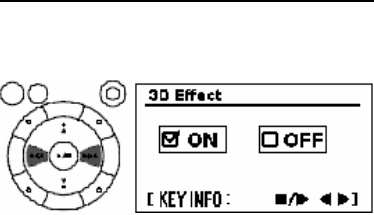
Key		Function	Setting
MENU	Display and Key operation		
SOUND		Setting - Equalizer - 3D Effect - Def Volume	① Press “MENU” ② Use ◀▶ to select the “DISPLAY” menu.
			

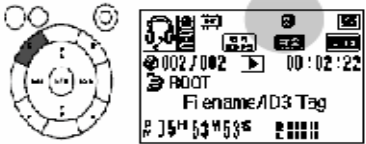
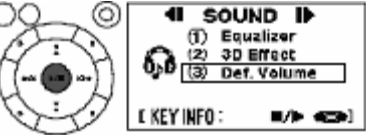
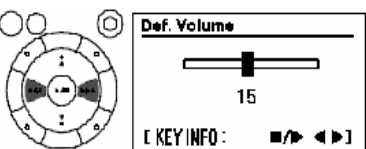
Equalizer		8 Equalizer - Normal: “NOR” - Jazz: “JAZ” - Classic: “CLA” - POP: “POP” - ROCK: “ROC” - LIVE: “LIV” - LOW-CUT: “LOW” - Hi-CUT: “HI” LOW-CUT: Remove noise at a low frequency. Good for recording AM/FM Hi-CUT: Remove noise at a high frequency. Good for recording AM/FM	③ Select “Equalizer” using ▲▼ and press ▶/■ ④ Select desired option using ▲▼◀▶
			
		Complete Setting	Press ▶/■ to complete setting and exit.
3D Effect			③ Select “3d Effect” using ▲▼ and press ▶/■ ④ Setting 3D Effect - Select desired option using ◀▶ - Press ▶/■ to complete setting and exit.
			

			<p>⑤ 3D Icon will be displayed.</p>
<p>Def Volume</p>	 	<p>Set the default volume you want the unit to use.</p> <p>Def volume options: 10,11,12,13,14,15,16,17, 18,19,20,21,21,22,23,24,25</p>	<p>③Select “Def Volume” using ▲▼ and press ►/■</p> <p>④Select desired option using ◀▶</p>
		<p>Complete Setting</p>	<p>Press ►/■ to complete setting and exit.</p>

IX. PLAY STYLE MENU

Press and hold Mode to bring up the Play Style menu.

- ① Normal Play (Organizes files in folders)

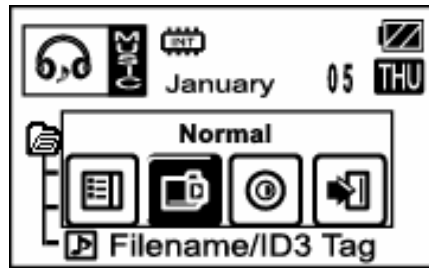

- ② File List (Displays files one after the other. Folders are not displayed)

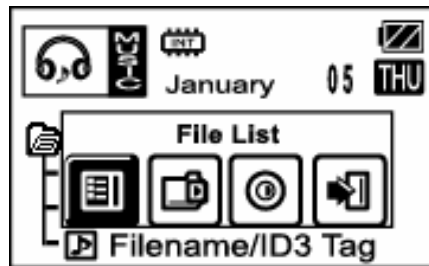

- ③ Book Mark Play (Displays your play list)

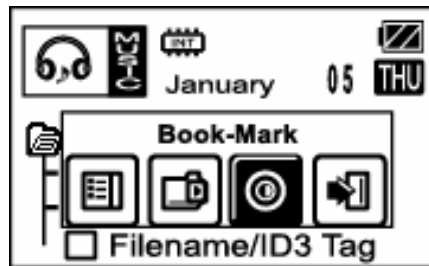

- ④ Exit

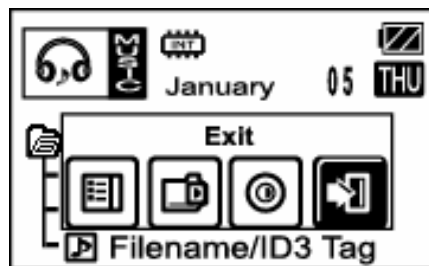

X. FURTHER OPERATION

1. Playback Speed

The playback speed (while playing a file) can be changed using the rewind or fast forward keys. (- short press; 10 seconds a second) (- - long press; 1 minute a second)

While Playing back

1) Forward and Rewind

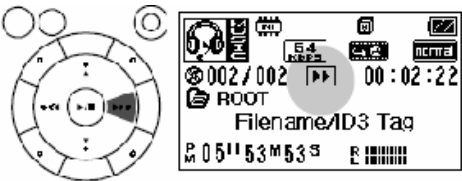
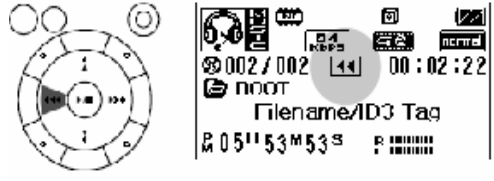
Forward (▶▶)	Rewind(◀◀)
	
<p>▶▶ : Display will show ▶▶(- Short) on the LCD and the file will fast-forward 10 seconds a second until the end of the file.</p> <p>▶/■ : Return to a normal play speed.</p>	<p>◀◀ : Display will show ◀◀(- short) on the LCD and the file will rewind 10 seconds a second until the end of the file.</p> <p>▶/■ : Return to a normal play speed .</p>
<p>▼ : Skip current file and play the next file.</p> <p>▲ : Skip current file and play the previous file.</p>	

2) Playback Speed



You can change the playback speed of a file by pressing the “SPEED” button. Each press will speed up or slow down the file as follows: x1.3, x1.5, x0.5, x0.7 and back to normal. This function only works with MP3 files.

2. AM/FM Radio

1) FM Radio Reception

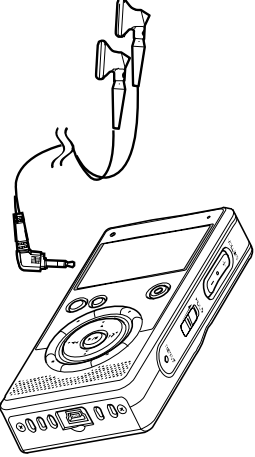
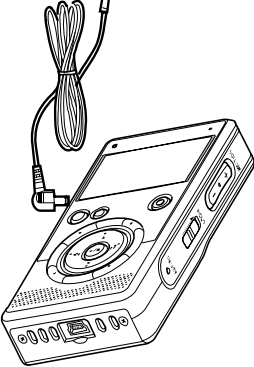
① Stereo Earphone	② External Antenna
	
Stereo earphone acts as the antenna for the FM radio.	Plug in the provided Ext Antenna into the phones jack; in order to listen to FM broadcasts using the speaker.

2) AM Radio Reception

The AM antenna is embedded in the unit. You are not required to plug in an external antenna in order to listen to AM radio. Please avoid placing the unit near electrical devices such as a computer, an iron structure building, a TV, or in a closed environment as this can interfere with your ability to get good reception. Place the unit near a window to get the best reception.

☞ If you set “**TUNER SCREEN OFF**” in the **DISPLAY MENU**, reception will be better.

Noise from LCD operation is decreased by turning the LCD off.

When the tuner screen is set off, pressing any button will allow you to view the display.

Auto Seek: If you press and hold <◀ or ▶> about 1 second, the unit will attempt to find an audible broadcast channel. This will save you time in an unfamiliar area. After finding a station, Auto Seek will stop. When using Auto Seek to find a station, precise **TUNING** may not be available, in that case please perform a fine adjustment using the REW or FF key.

Preset: User can save (preset) up to 10 desired radio stations for quick access:

- ① Select a desired station to preset.
- ② Press “▶/■”, and “Preset” will display and flicker on the LCD screen.
- ③ Select a desired preset No (1-10) using ▲▼ and save the preset by pressing ▶/■

Note: If you take too long (4 seconds) to confirm (i.e. push a button during the process) you will have to start all over again.

☞ **Selecting a preset radio station**

To quickly select a preset station press ▲▼ when in AM/FM mode.

To go back to normal tuning, use ◀▶

3. Formatting memory

- ① Press “MENU”
- ② Move to desired setting (INT/EXT Format) using ▲▼

③ Select “Int Format” and press ▶/■
④ Use ◀▶ to select “YES”
⑤ Press ▶/■ to complete setting and exit.
③ Select “Ext Format” and press ▶/■ to format card
④ Use ◀▶ to select “YES” or “NO”

☞ All files are lost when performing a format.

4. Complete Format

If you wish to return the Radio YourWay LX back to its factory settings, you may perform a complete format.

1. With the Radio YourWay LX powered on, enable the Hold switch on the side
2. Press and hold the Erase button for 10 seconds, then gently press the Reset button
3. Keep holding Erase until you see “Format Please Wait” on the display
4. Release Erase, disable the Hold switch

Restart the LX

XI. COMPUTER CONNECTION

1 Win XP, 2000, ME, and Mac OSX +

You can connect the unit to a computer using the provided USB cable.

No special application is required unless you use Win98SE.

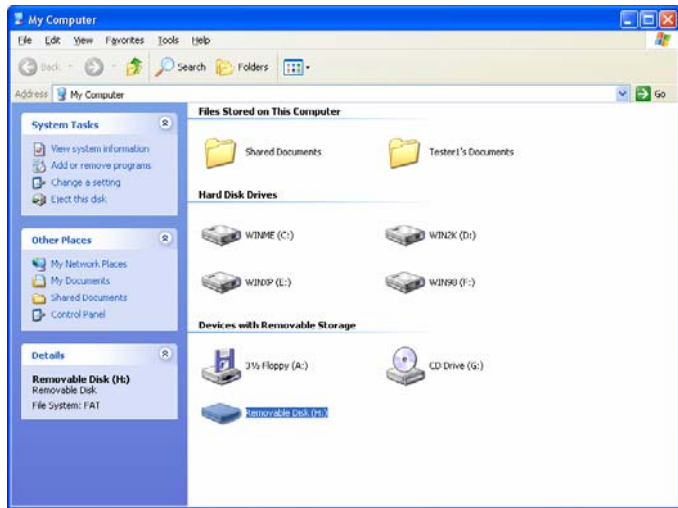
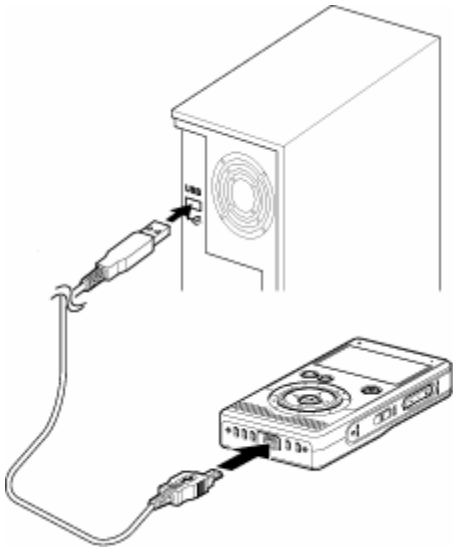

When you connect the unit to a USB port, it will be recognized as a “Removable Disk” in Win XP, 2000, ME. Mac users will see it as a nameless drive.

2 Install Driver for Win98SE

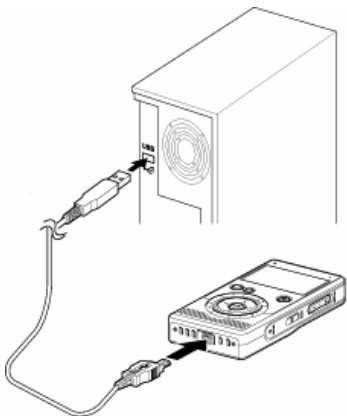

① Connect device to USB port



② Click “Unknown Device” window



③ Check 'Search for the best driver for your device' and click 'next'



④ Check 'Specify a location'

⑤ Insert Driver CD inside your computer's CDROM

⑥ Click "Next" button

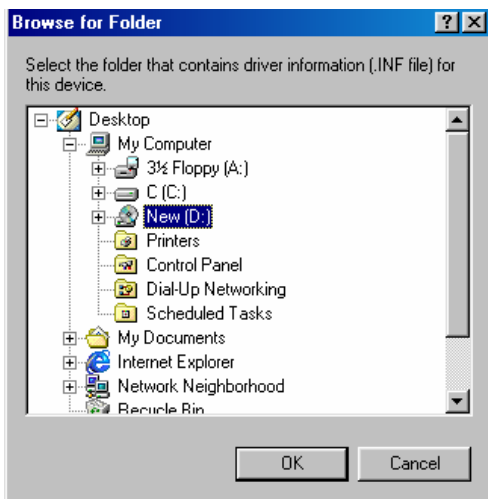

⑦ Click your CDROM drive (D: in most cases) and click "OK"



⑧ Click 'Next'



⑨ Click 'Finish' to complete installation

☞ To make sure the installation has been successfully completed, check for the device in the device manager: [My Computer]-[Control Panel]-[System]-[Device Manager]

3. PC Connection Display

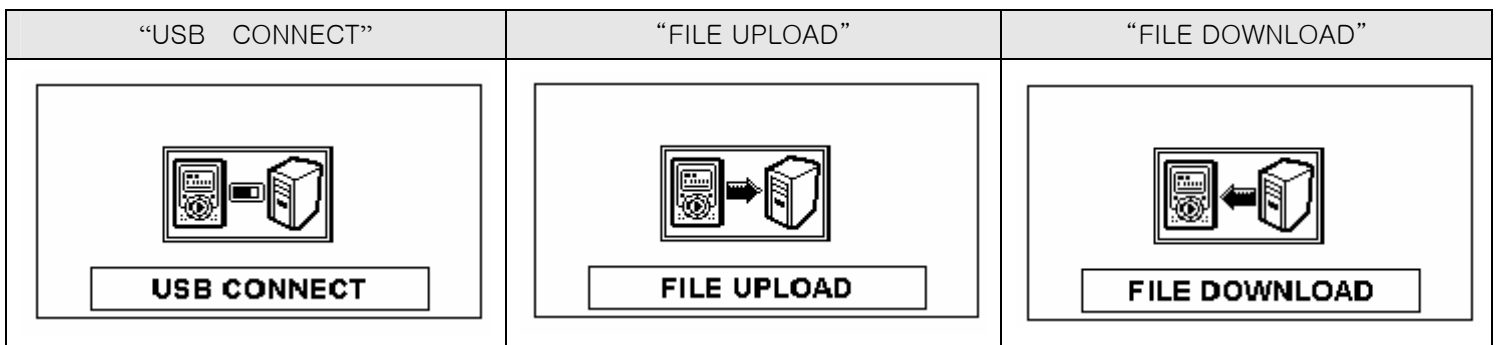

- Transfer File From PC to Set

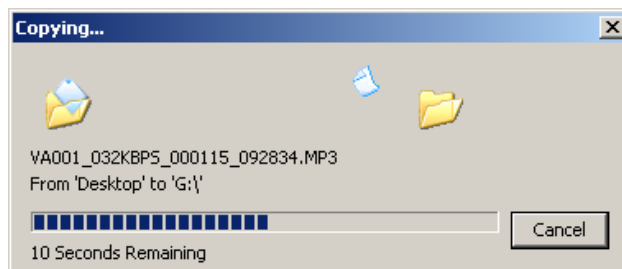
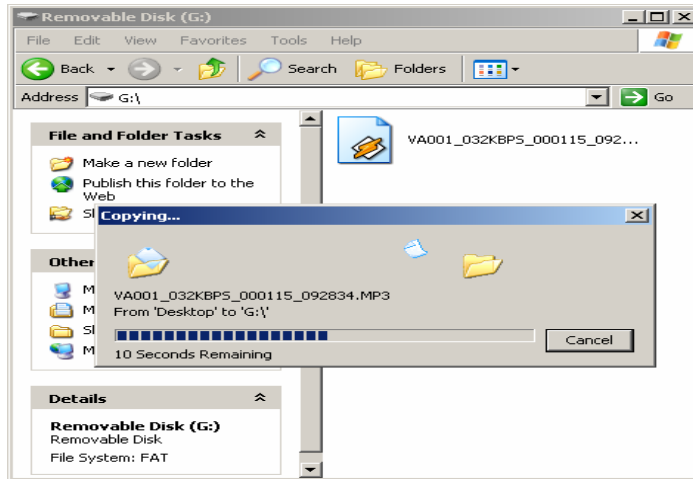

4. Safely Removing Hardware from a PC

You are required to safely remove this device BEFORE disconnecting the device from the USB port.

- ① Close open files

If there are any open files in the unit, you should close them to avoid any errors.

- ② Click , in the tool bar:



- ③ The following window will show, select USB Mass Storage Device and click ok. After that, select USB Mass Storage device again and click stop.

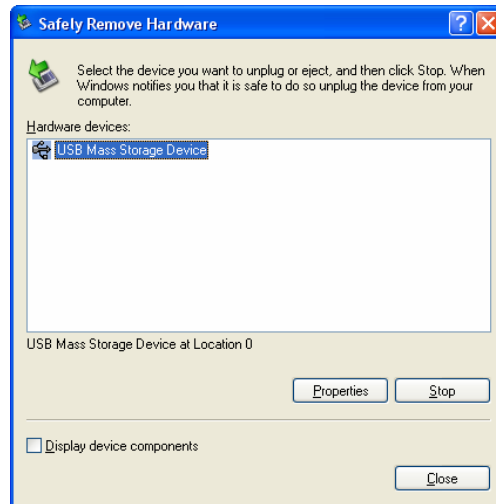

- ④ When you get the message below, it is safe to disconnect the USB cable from the PC.



XII. DISPLAY MESSAGES

NO FILE

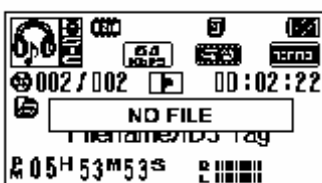

CHARGING



CHARGE COMPLETE



CHARGE NEEDED



CONNECTING USB TO PC



UPLOADING FILE TO PC



DOWNLOADING FILE TO SET



BOOKMARK ADDED

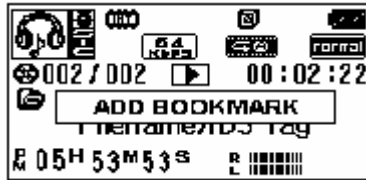

BOOKMARK FAILED

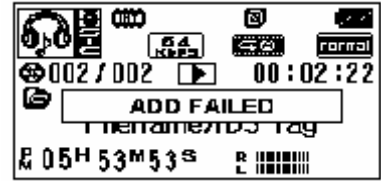

DELETE COMPLETE

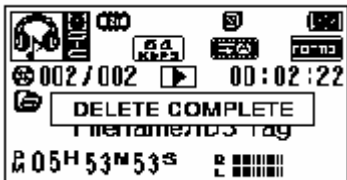

NO TIMER RECORDING

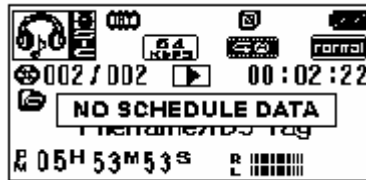

INITIALIZING

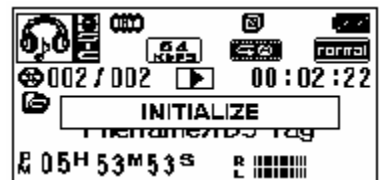

SEARCHING FILE

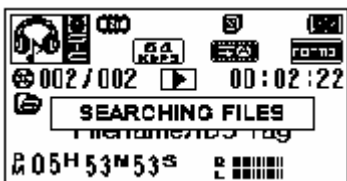

MEMORY IS FULL

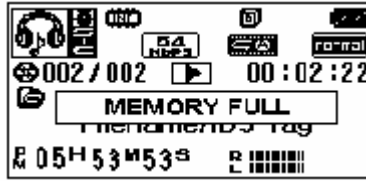

INDEX IS FULL

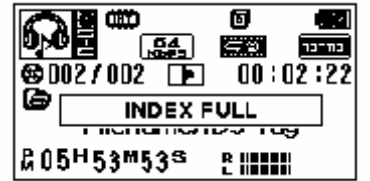

NO MEMORY CARD FOUND

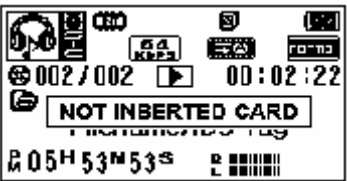

CAN'T READ SD-CARD



NOT ENOUGH MEMORY SPACE

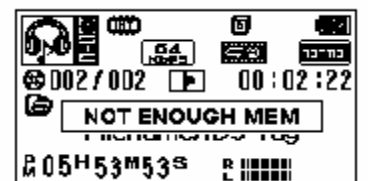

OVERLAPPING SCHEDULE

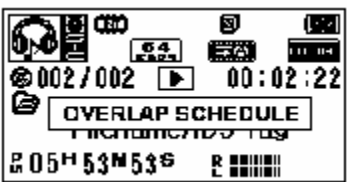

NEED SETTING TIME



NO BOOKMARK



FAILED INITIALIZING

FAILED to DELETE FILE

FAILED UPGRADING

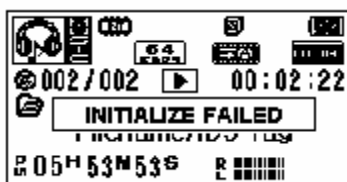

NO INDEX

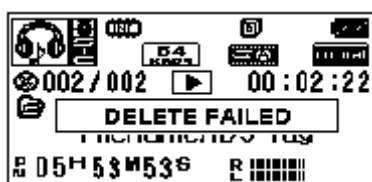

END TIME NOT SET

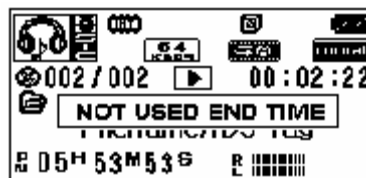
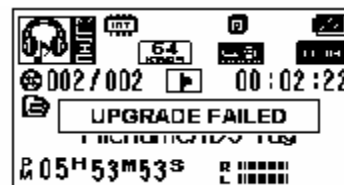

General Specification

MODEL		RadioYourWay LX
VOICE RECORD/ PLAY	RECORD TIME	128MB: 510Min / 512MB: 2040Min at 32Kbps
	MODE	MP3 FORMAT
	FILE	VOICE : 999pcs MP3
	FM Record	Stereo (87.5MHz~108MHz)
	AM Record	530 ~ 1710KHz
	Timer Record	Date / Week
	Mic	Built-in Mic / Line (External Mic)
	Record Device	Built-in Flash Memory / EXT (MMC/ SD CARD)
	S/N	45db (62dB input 1KHz, speaker output 200mW)75KHz
	Distortion	3%±0.2 (62dB input 1KHz , speaker output 100mW)
	Freq. Response	400Hz~32KHz (-6dB)
	Output Power	Max 8mW (stereo earphone 16ohm)
	Repeat play	One message repeat / Continue message repeat / A-B repeat / Random
	Timer Record	20 Timer Recording Slots
FM RADIO (stereo)	S/N	45dB at 1mV 98.1MHz
	Distortion	0.8%(max) at 1mv 98.1MHz Δf=22.5KHz
	Freq. Response	350Hz±30Hz, 3KHz±25KHz (150Hz~25KHz,60dBuV)
	Sensitivity	5uV at S/N=26dB
	Frequency Cover range	87.5 ~ 108MHz
	Preset Mode	10 Radio station
AM RADIO	S/N	35dB
	Distortion	3%

	Freq, Response	150Hz – 15KHz at 0dB
	Sensitivity	68dbuV at 1KHz
	Frequency Cover range	530 ~ 1710KHz
	Preset Mode	10 Radio station
MP3	Bit/rate	32Kbps~256Kbps (MPEG 1/2 LAYER 3)
	S/N	85dB up (1KHz input 0dB)
	Distortion	0.3%±0.05 (1KHz input 0dB)
	Freq, Response	20Hz~20KHz
	Earphone	Max 8mW (16ohm)
	EQ	EQ : NORMAL, ROCK, POP, CLASSIC, LIVE, JAZZ, Low-Cut, Hi-Cut
	Repeat play	NOR/ NOR1/ 1ALL/ ALL/Random
Sound	3D Sound	
PC interface	communication	USB 1.1
	System	CPU: more than 200MHz , RAM: more than 64MB
	OS	Windows98SE , Windows2000 , Windows ME , Windows XP, MAC OS 9.2 & later, OS X
	Sound card	Sound Blaster 16 compatible
	Display	more than 640X480
IN/OUT JACK	Ext mic/line in	φ 3.5 plug-in power microphone(mini plug / stereo) IMP less than 3KΩ
	Earphone	φ 3.5 earphone(mini plug / stereo) IMP less than 16Ω
	DC JACK	Mini B Type
	USB	Mini B type (PC : A TYPE)
SPEAKER	Diameter	φ 16(IMP 8Ω)
	Max output	200mW (volume max)
VOLUME	Digital volume (30 step)	
MEMORY	Nand Flash Memory	
LED	Recording display LED (RED)	
LCD (FSTN)	MODE	VOICE/AM/FM/MP3
	Messages	01~999(INDEX)
	EQ	NORMAL, ROCK, POP, CLASSIC, LIVE, JAZZ, Low-Cut, Hi-Cut
	Repeat	NOR/ NOR1/ 1ALL/ ALL/Random
	CLOCK	CLOCK
ADAPTOR	DC5V / 500mA(cUL)	
KEY FUNCTION	FF/ PLAY/ STOP/ REW/ FSEARCH/ RSEARCH/ REC/ REPEAT/ MODE/ ERASE/ EQ/ A-B/ TIMER/ VOL+/ VOL-/HOLD/SPEED	
POWER requirement	RECHARGEABLE Li-polymer 3.7V/1000mA	
Battery life	MP3 PLAY	Approx 15hour during the mp3 play (earphone output: volume middle position)
	VOICE PLAY	Approx 15hour during the voice play (earphone output: volume middle position)
	RADIO RECIEVING	Approx 15hour during the radio play (earphone output: volume middle position)

	RADIO/VOICE REC	Approx 9hour during the radio play (earphone output: volume middle position)
Operating Temp		0°C – +40°C
Accessory		Line in cable(1)/ Win 98SE Driver CD (1)/ Neck strap (1)/ stereo earphone (1) / FM EXT ANT (1)/ AC/DC adapter(1) / USB cable (1)/ manual (1)
SIZE		2.36" (W) X 3.93" (H) X 0.78" (D)

Warranty

- If any defect or error occurs, stop using the product and contact PoGo! Products, Inc.

General Directory Number: (714) 671-1854

- Warranty (Warranty Regulation)

PoGo! Products will guarantee a repair or service for a period of one year from the original date of purchase. If any defect or error occurs during the warranty period, please contact us directly at techsupport@pogoproducts.com.

A dated order/receipt is **REQUIRED** for all warranty claims. Ensure the above information is provided and if it not, consult with the shop you purchased the unit from to obtain it

(Repair or Service)

- This product is manufactured under a strict quality control and inspection process
- If any defect or error occurs under normal operation, in accordance with the caution or notes in this manual during the warranty period, you are entitled to a repair or exchange from our company
- The repair/service does NOT include shipping charges

- There will be a charge for the following:

- 1) Without a dated purchase order/receipt
- 2) If the original date of purchase is passed the warranty period or the dated purchase order/receipt

is modified in any way

- 3) For any defect or damage resulting from misuse, abnormal use, abnormal condition, improper storage and/or exposure to direct sunlight or moisture
- 4) For any defect or damage resulting from any unauthorized modification or repair
- 5) For any defect or damage resulting from disasters such as fire, air pollution, earthquake or war
- 6) For any defect or damage resulting from a leak of the battery
- 7) Consumable item such as the battery

- The warranty is only valid for service in the USA.

(CAUTION: When Shipping The Product For Warranty Service)

- If you need to ship the product for warranty service, please do the following:

1. Contact us at techsupport@pogoproducts.com for a return authorization number.
2. Enclose the original dated purchase order/receipt with the product during the warranty period
3. Avoid damage to the product during shipping/transportation using proper packing materials
4. Use registered and/or insured mail to prevent a loss

- The customer shall bear all costs of shipping the product properly.

- If any defect occurs during the use of this product, contact the shop you purchased or PoGo! Products, Inc.

- Replacement, repairs, or refunds must be in accordance with our policy and can be found at:

<http://www.pogoproducts.com/support.html>

- If you have any further questions about this product, please contact PoGo! Products, Inc.



PoGo! Products Inc
590 W Central Ave Suite E
Brea, CA 92821
Phone: 714-671-1854

The warranty may only be used in the USA. Please keep your dated purchase order/receipt safely as it is required for any warranty service.